

## Nonrelativistic Hard-Pion Production and Current-Field Algebra

M. K. Banerjee, C. A. Levinson, M. D. Shuster,\* and D. A. Zollman†

*Department of Physics and Astronomy, University of Maryland, College Park, Maryland 20742*

(Received 20 July 1970)

The mass dispersion approach of Fubini and Furlan is applied to single-pion production in nucleon-nucleon collisions. The finite-mass correction to the zero-mass limit is exhibited, and it is shown that in a nonrelativistic approximation this correction leads directly to a simple distorted-wave Born approximation for the physical amplitude. The transition operator is determined directly from the nucleon field-chirality equal-time commutation relation and, in the rest frame of the pion, is given by the standard interaction term.

### I. INTRODUCTION

In a recent paper, Fubini and Furlan<sup>1</sup> discussed a dispersion relation for pion-nucleon scattering. In this approach the dispersion variable is the pion mass, and the soft-pion limit is the value of the amplitude at zero pion mass. We have applied this dispersion approach to the production of one pion in nucleon-nucleon collisions. Using the value of the amplitude at the soft-pion limit, we are able to make a connection with the nonrelativistic production theory. By "boosting" the nonrelativistic amplitude to the pion mass shell, we are able to derive a nonrelativistic production potential for pions in nucleon-nucleon collisions. To apply this method we must know the equal-time commutation relation (ETCR) of the nucleon field with the chirality. This ETCR and the residues of three poles establish the production amplitude for zero pion mass. The corrections due to the finite mass of the pion are then in the form of a dispersion integral. When this correction is evaluated under suitable approximations, it leads to the nonrelativistic distorted-wave approximation where, in the pion rest frame, the transition operator is

$$-ig_A \frac{\sqrt{2} m_\pi^2}{f_\pi} \sum_n \left( i\vec{\sigma}_n \cdot \vec{\nabla}_n \frac{m_\pi}{M} \right)^{\frac{1}{2}} \tau^a,$$

where

$\tau^a$  = the  $a$ th component of the isospin operator,  
 $\vec{\sigma}$  = the nucleon spin operator,  
 $f_\pi$  = the pion decay constant,

$g_A$  = axial-vector-nucleon coupling constant,  
 $m_\pi$  = the pion mass,  
 $M$  = mass of the nucleon,

and  $\vec{\nabla}$  acts on the nucleon space variables  $\vec{x}_n$ . The summation is over the nucleons. In the pion rest frame this transition operator is the operator usually used in the nonrelativistic approaches to this process.<sup>2</sup>

This result is rather general. Ericson, Figureau, and Molinari<sup>3</sup> first demonstrated that the Fubini-Furlan mass dispersion formalism is quite similar to the nonrelativistic scattering equations involving off-energy-shell scattering operators. The dependence of the relativistic amplitude on the meson-mass variable is quite analogous to the dependence of the nonrelativistic off-shell amplitude on the off-shell energy variable. Hence, it is not surprising that in the nonrelativistic domain the Fubini-Furlan method leads to the distorted-wave approximation. However, the important point is that the transition operator can be derived directly from the ETCR between the nucleon field operator and the chirality without any assumptions about the pion-nucleon interaction Hamiltonian.

In Sec. II we develop the Fubini-Furlan approach for pion production in nucleon-nucleon collisions. In Sec. III, by considering the leading singularity in the mass dispersion relation, we show that the mass dispersion approach leads directly to a nonrelativistic distorted-wave approximation. In Sec. IV we consider several more singularities and are thus able to determine the most important corrections to the distorted-wave approximation.

### II. MASS-DISPERSION RELATION FOR $NN \rightarrow NN\pi$

The  $S$  matrix for the production of a pion in nucleon-nucleon collisions is given by<sup>4</sup>

$$S = -i(2\pi)^4 \delta^{(4)}(p_f + k - p_1 - p_2) \langle f\pi | \bar{j}(0) | p_1 s_1 \rangle u(p_2 s_2), \quad (\text{II.1})$$

where  $(p_1, s_1)$  and  $(p_2, s_2)$  are the four-momenta and spins for the initial nucleons,  $k$  is the pion four-momentum, and  $p_f$  is the four-momentum of the final two-nucleon system. [For most of the following development the state  $f$  may correspond to either a deuteron or an unbound two-nucleon system. When a distinction must be made, we shall use  $d$  for the deuteron and  $(p_3, s_3)$  and  $(p_4, s_4)$  for the unbound system.]  $\bar{j}(x)$

$= \bar{\psi}(x)(-i\vec{\nabla} - M)$ , where  $\psi(x)$  is the nucleon field operator. We shall always work in the coordinate system where the pion is at rest. Hence  $k = (m_\pi, 0, 0, 0)$ .

We shall study the expression

$$F(q) = \int e^{iq \cdot x} \langle f | [D^a(x), \bar{j}(0)] \theta(x_0) | p_1 s_1 \rangle u(p_2 s_2), \quad (\text{II.2})$$

where  $q = (q_0, 0, 0, 0)$ , as a function of the pion mass  $q_0$ .  $D^a(x) = \partial_\mu A_\mu^a(x)$  is the divergence of the axial vector current  $A_\mu^a(x)$ , and is used as an interpolating field for the pion.

Since we have chosen the coordinate system in which the space components of  $q$  vanish,  $F(q)$  becomes a function of  $q_0$  alone, and  $F(m_\pi)$  is proportional to the physical production amplitude. To fix the constant of proportionality between  $F(m_\pi)$  and the physical pion production amplitude we must know the vacuum-to-one-pion matrix element of  $D^a(x)$ . This factor is given by the  $\beta$  decay of the pion by<sup>5</sup>

$$\langle \pi^a | D^a(0) | 0 \rangle = f_\pi / \sqrt{2}. \quad (\text{II.3})$$

For convenience we will not multiply  $F(q_0)$  by the factor (II.3) until we obtain the final result.

It is important to emphasize that the momenta  $p_f$ ,  $p_1$ , and  $p_2$  are held fixed and satisfy the relation  $p_1 + p_2 - p_f = k = (m_\pi, 0, 0, 0)$  while  $q = (q_0, 0, 0, 0)$  and  $q_0$  varies. The mass of the reduced-out pion equals  $q_0$  and the (mass)<sup>2</sup> of the reduced-out nucleon is  $(p_f - p_1 - q)^2$ . Hence, at  $q_0 = 0$  not only is the pion off the mass shell, but the reduced nucleon has a (mass)<sup>2</sup>  $= (p_f - p_1)^2 = (p_2 - k)^2$ .

The limit differs from the soft-pion limit of Adler<sup>6</sup> where only the pion is off mass shell and  $p_f = p_1 + p_2$ . Thus, in the Adler soft-pion approach the amplitude involves an on-shell nucleon-nucleon scattering amplitude factor, while in our method the zero-pion-mass limit will be shown to involve an off-mass-shell nucleon-nucleon scattering amplitude factor.

We now proceed to evaluate the  $q_0 = 0$  limit,  $F(0)$ . Integrating (II.2) by parts several times we obtain

$$\begin{aligned} F(q_0) &= \int d^4x \langle f | [D^a(x), \bar{j}(0)] \theta(x_0) | p_1 s_1 \rangle (-q_0^2 + m_\pi^2) e^{iq_0 x_0} u(p_2 s_2) \\ &= - \int d^4x \langle f | [A_0^a(x), \bar{j}(0)] \delta(x_0) | p_1 s_1 \rangle (-q_0^2 + m_\pi^2) e^{iq_0 x_0} u(p_2 s_2) \\ &\quad - i q_0 \int d^4x \langle f | [A_0^a(x), \bar{j}(0)] \theta(x_0) | p_1 s_1 \rangle (-q_0^2 + m_\pi^2) e^{iq_0 x_0} u(p_2 s_2). \end{aligned} \quad (\text{II.4})$$

Thus,

$$\begin{aligned} F(0) &= - \int d^4x \langle f | [A_0^a(x), \bar{j}(0)] \delta(x_0) | p_1 s_1 \rangle u(p_2 s_2) m_\pi^2 + m_\pi^2 \lim_{q_0 \rightarrow 0} q_0 \sum_n \frac{\langle f | \bar{j}(0) | n \rangle \langle n | A_0^a(0) | p_1 s_1 \rangle u(p_2 s_2) (2\pi)^3 \delta^{(3)}(\vec{n} - \vec{p}_1)}{q_0 + n_0 - p_{10} + i\epsilon} \\ &\quad - m_\pi^2 \lim_{q_0 \rightarrow 0} q_0 \sum_n \frac{\langle f | A_0^a(0) | n \rangle \langle n | \bar{j}(0) | p_1 s_1 \rangle u(p_2 s_2) (2\pi)^3 \delta^{(3)}(\vec{p}_f - \vec{n})}{p_{f0} + q_0 - n_0 + i\epsilon}. \end{aligned} \quad (\text{II.5})$$

The ETCR in (II.5) is related to the nucleon field-chirality ETCR which has been studied by many authors.<sup>7-10</sup> In addition, Banerjee and Levinson<sup>10</sup> have studied the ETCR appearing in (II.5). Their result is

$$\int d^4x [A_0^a(x), \bar{j}(y)] \delta(x_0 - y_0) = [\bar{j}(y) + 2M\bar{\psi}(y)] \gamma_{5/2}^a \tau^a. \quad (\text{II.6})$$

They have used this ETCR to derive the pion-nucleon scattering-length formula of Weinberg and others.<sup>11</sup> [Since a derivation of (II.6) has not been published, it is presented in Appendix A.]

Putting (II.6) into (II.5) we have for the first term in (II.5)

$$\begin{aligned} F_{\text{ETCR}}(0) &= - \langle f | 2M\bar{\psi}(0) + \bar{j}(0) | p_1 s_1 \rangle m_\pi^2 \gamma_{5/2}^a \tau^a u(p_2 s_2) \\ &= - \langle f | \bar{j}(0) | p_1 s_1 \rangle m_\pi^2 \frac{\not{p}_f - \not{p}_1 + M}{\not{p}_f - \not{p}_1 - M} \gamma_{5/2}^a \tau^a u(p_2 s_2). \end{aligned} \quad (\text{II.7})$$

Since  $p_f - p_1 = p_2 - k$ , (II.7) becomes

$$F_{\text{ETCR}}(0) = \langle f | \bar{j}(0) | p_1 s_1 \rangle \frac{m_\pi^2}{\not{p}_2 - \not{k} - M} \not{k} \gamma_{5/2}^a \tau^a u(p_2 s_2). \quad (\text{II.8})$$

Expression (II.8) is precisely the contribution of all Feynman diagrams where a nucleon ( $p_2, s_2$ ) emits a meson ( $k$ ) by the axial-vector vertex and then scatters against the nucleon ( $p_1, s_1$ ). After emitting the meson, the nucleon carries four-momentum ( $p_2 - k$ ) corresponding to the propagator in (II.8).

We examine now the remaining terms of (II.5). As  $q_0$  goes to zero, only intermediate states for which

$n_0 = p_{10}$  will contribute to the second term of (II.5). Thus, only the one-nucleon state contributes. Performing the phase-space integration, this term becomes

$$\frac{m_\pi^2 M}{p_{10}} \sum_{s'} \langle f | \bar{j}(0) | p_1 s' \rangle \langle p_1 s' | A_0^a(0) | p_1 s_1 \rangle u(p_2 s_2). \quad (\text{II.9})$$

For a nonvanishing contribution from the third term in (II.5)  $n$  must be a deuteron if  $f$  is a deuteron. However,  $\langle d | A_0^a(0) | d \rangle$  vanishes due to isospin conservation.

For an unbound two-nucleon system, we write the third term of (II.5) as

$$\begin{aligned} -m_\pi^2 \lim_{q_0 \rightarrow 0} \sum_n q_0 \left[ \frac{\langle p_3 s_3 | A_0^a(0) | n \rangle \langle n | p_4 s_4 | \bar{j}(0) | p_1 s_1 \rangle_c}{p_{30} - n_0 + q_0 + i\epsilon} (2\pi)^3 \delta^{(3)}(\vec{p}_3 - \vec{n}) \right. \\ \left. - \frac{\langle p_4 s_4 | A_0^a(0) | n \rangle \langle p_3 s_3 | \bar{j}(0) | p_1 s_1 \rangle_c}{p_{40} - n_0 + q_0 + i\epsilon} (2\pi)^3 \delta^{(3)}(\vec{p}_4 - \vec{n}) \right. \\ \left. - \frac{\langle p_3 s_3 | p_4 s_4 | A_0^a(0) | n \rangle_c \langle n | \bar{j}(0) | p_1 s_1 \rangle_c}{p_{30} + p_{40} - n_0 + q_0 + i\epsilon} (2\pi)^3 \delta^{(3)}(\vec{p}_3 + \vec{p}_4 - \vec{n}) \right] u(p_2 s_2), \quad (\text{II.10}) \end{aligned}$$

where a subscript  $c$  on a matrix element denotes a connected element. The first two terms can be treated exactly as (II.9). The last term contains a two-nucleon cut with branch point at  $q_0 = 0$ . However, due to vanishing phase-space the discontinuity vanishes at the branch point. Collecting the results of (II.8) to (II.10), we have for the process  $N(p_1) + N(p_2) \rightarrow N(p_3) + N(p_4) + \pi^a(k)$

$$\begin{aligned} F(0) = \langle p_3 s_3 | p_4 s_4 | \bar{j}(0) | p_1 s_1 \rangle_c \frac{m_\pi^2}{p_2 - k - M} \not{k} \gamma_5 \frac{1}{2} \tau^a u(p_2 s_2) \\ + \frac{m_\pi^2 M}{p_{10}} \sum_{s'_1} \langle p_3 s_3 | p_4 s_4 | \bar{j}(0) | p_1 s'_1 \rangle_c \langle p_1 s'_1 | A_0^a(0) | p_1 s_1 \rangle u(p_2 s_2) \\ - \frac{m_\pi^2 M}{p_{30}} \sum_{s'_3} \langle p_3 s_3 | A_0^a(0) | p_3 s'_3 \rangle \langle p_3 s'_3 | p_4 s_4 | \bar{j}(0) | p_1 s_1 \rangle_c u(p_2 s_2) \\ + \frac{m_\pi^2 M}{p_{40}} \sum_{s'_4} \langle p_4 s_4 | A_0^a(0) | p_4 s'_4 \rangle \langle p_3 s_3 | p_4 s'_4 | \bar{j}(0) | p_1 s_1 \rangle_c u(p_2 s_2), \quad (\text{II.11}) \end{aligned}$$

and for  $N(p_1) + N(p_2) \rightarrow d + \pi^a(k)$

$$F(0) = \langle d | \bar{j}(0) | p_1 s_1 \rangle_c \frac{m_\pi^2}{p_2 - k - M} \not{k} \gamma_5 \frac{1}{2} \tau^a u(p_2 s_2) + \frac{m_\pi^2 M}{p_{10}} \sum_{s'_1} \langle d | \bar{j}(0) | p_1 s'_1 \rangle_c \langle p_1 s'_1 | A_0^a(0) | p_1 s_1 \rangle u(p_2 s_2). \quad (\text{II.12})$$

These two amplitudes are illustrated in Figs. 1 and 2, respectively. Each of the pion-nucleon vertices produce pions by axial-vector coupling.

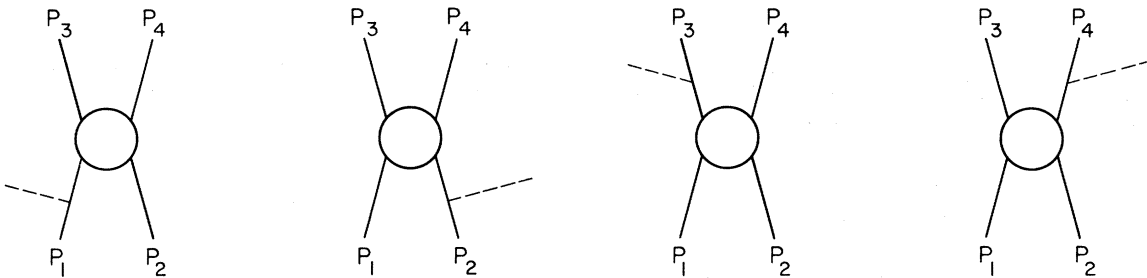

FIG. 1. Graphical description of  $F(0)$  for  $NN \rightarrow NN\pi$ . In all diagrams in this paper a solid line indicates a nucleon and a dashed line a meson.

Equations (II.11) and (II.12) are not symmetrical in the four nucleons. The term corresponding to emission by the reduced nucleon appears to be very different from the other terms. This is not surprising, since the reduced nucleon is off mass shell while the other three nucleons are on mass shell. We will now show that to a very good approximation we may write (II.11) and (II.12) in a symmetrical form.

Rationalizing the propagator we have

$$\frac{1}{\not{p}_2 - \not{k} - M} \not{k} \gamma_5 \frac{1}{2} \tau^a u(p_2 s_2) = \frac{\not{p}_2 + M}{-2p_2 \cdot k + m_\pi} \not{k} \gamma_5 \frac{1}{2} \tau^a u(p_2 s_2) - \frac{m_\pi^2}{-2p_2 \cdot k + m_\pi} \gamma_5 \frac{1}{2} \tau^a u(p_2 s_2). \quad (\text{II.13})$$

Since  $k = (m_\pi, 0, 0, 0)$ , (II.13) becomes

$$-(\not{p}_2 + M) \frac{1}{2p_{20} - m_\pi} \gamma_0 \gamma_5 \frac{1}{2} \tau^a u(p_2 s_2) + \frac{m_\pi}{2p_{20} - m_\pi} \gamma_5 \frac{1}{2} \tau^a u(p_2 s_2). \quad (\text{II.14})$$

The second term in (II.14) may be written as

$$\frac{m_\pi}{2p_{20} - m_\pi} \frac{(\not{p}_2 - M)}{2M} \gamma_5 \frac{1}{2} \tau^a u(p_2 s_2), \quad (\text{II.15})$$

and (II.14) becomes

$$-\sum_{s'} \frac{M}{2p_{20} - m_\pi} u(p_2 s') \bar{u}(p_2 s') \gamma_0 \gamma_5 \frac{1}{2} \tau^a u(p_2 s_2) - \frac{m_\pi}{2p_{20} - m_\pi} \sum_{s'} v(p_2 s') \bar{v}(p_2 s') \gamma_5 \frac{1}{2} \tau^a u(p_2 s_2). \quad (\text{II.16})$$

Thus the first term connects the emitting nucleon to positive-energy states only, and the second term connects the emitting nucleon to negative-energy states only.

Therefore, we will consider the nucleon scattering vertices  $\langle f | \bar{j}(0) | p_1 s_1 \rangle u(p_2 s_2)$  and  $\langle f | \bar{j}(0) | p_1 s_1 \rangle v(p_2 s_2)$ . The two vertices can be written as<sup>12</sup>

$$\begin{aligned} \langle f | \bar{j}(0) | p_1 s_1 \rangle u(p_2 s_2) &= \sum_{i=1}^5 F_i \bar{u}(p_3 s_3) \Gamma_i u(p_1 s_1) \bar{u}(p_4 s_4) \Gamma_i u(p_2 s_2) - (p_1 \leftrightarrow p_2), \\ \langle f | \bar{j}(0) | p_1 s_1 \rangle v(p_2 s_2) &= \sum_{i=1}^5 F_i \bar{u}(p_3 s_3) \Gamma_i u(p_1 s_1) \bar{u}(p_4 s_4) \Gamma_i v(p_2 s_2) + [u(p_1 s_1) \leftrightarrow v(p_2 s_2)], \end{aligned} \quad (\text{II.17})$$

where the  $\Gamma_i$  are the usual scalar, pseudoscalar, vector, axial-vector, and tensor  $\gamma$  matrices (isospin indices have been suppressed) and the  $F_i$  are the appropriate form factors.

In Sec. III of this paper we will be interested in energy regions where the two nucleons can be described in terms of nonrelativistic quantum mechanics. Since the nucleon-nucleon scattering is dominated by the scalar interaction in this energy region,<sup>13</sup> we consider only the scalar term in (II.17) and obtain

$$\frac{\langle f | \bar{j}(0) | p_1 s_1 \rangle v(p_2 s_2)}{\langle f | \bar{j}(0) | p_1 s_1 \rangle u(p_2 s_2)} \approx \text{velocity of final nucleons}. \quad (\text{II.18})$$

Thus, the ratio (II.18) is small, since the kinetic energies of the final nucleons are near zero in the region of interest. In addition, the first term in (II.16) is proportional to  $|\vec{p}_2|/(2p_{20} - m_\pi)$ , while the second term is proportional to  $m_\pi/(2p_{20} - m_\pi)$ . Since  $|\vec{p}_2| \geq (m_\pi M)^{1/2}$  the ratio becomes

$$\frac{\sum_{s_2'} \langle f | \bar{j}(0) | p_1 s_1 \rangle v(p_2 s_2') \bar{v}(p_2 s_2') \gamma_5 u(p_2 s_2)}{\sum_{s_2'} \langle f | \bar{j}(0) | p_1 s_1 \rangle u(p_2 s_2') \bar{u}(p_2 s_2') \gamma_0 \gamma_5 u(p_2 s_2)} \approx \frac{1}{2} \left( \frac{m_\pi}{M} \right)^{1/2} \times (\text{velocity of final nucleons}).$$

Therefore, we drop the second term in (II.16) and write

$$\frac{1}{\not{p}_2 - \not{k} - M} \not{k} \gamma_5 \frac{1}{2} \tau^a u(p_2 s_2) \approx -\frac{2M}{2p_{20} - m_\pi} \sum_{s_2'} u(p_2 s_2') \bar{u}(p_2 s_2') \gamma_0 \gamma_5 \frac{1}{2} \tau^a u(p_2 s_2).$$

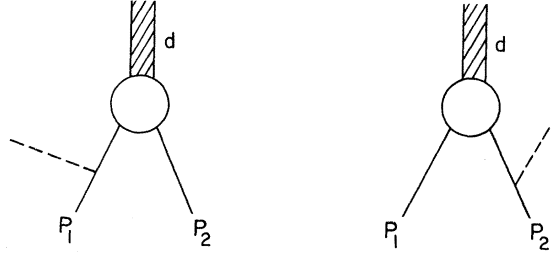

FIG. 2. Graphical description of  $F(0)$  for  $NN \rightarrow d\pi$ .

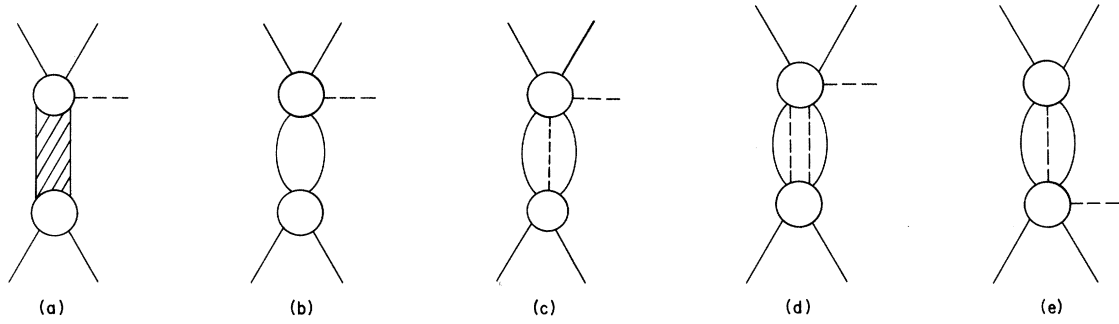

FIG. 3. Some of the corrections to  $F(0)$ . (a) does not contribute if the final state is a deuteron.

This term will be the same as the other three if  $2M/(2p_{20} - m_\pi)$  is replaced by  $g_A M/p_{20}$ . For processes in the low-energy region such replacement will make a small (less than 10%) error. Therefore, we write

$$\frac{1}{p_2 - k - M} k \gamma_{5/2} \tau^a u(p_2 s_2) \approx \frac{M}{p_{20}} \sum_{s'_2} u(p_2 s'_2) \langle p_2 s'_2 | A_0^a(0) | p_2 s_2 \rangle. \quad (\text{II.19})$$

Using (II.19) we recast (II.11) and (II.12) in a symmetrical form

$$\begin{aligned} F(0) = & -\frac{m_\pi^2 M}{p_{20}} \sum_{s'_2} \langle p_3 s_3; p_4 s_4 | \bar{j}(0) | p_1 s_1; p_2 s_2 \rangle_c u(p_2 s'_2) \langle p_2 s'_2 | A_0^a(0) | p_2 s_2 \rangle \\ & + \frac{m_\pi^2 M}{p_{10}} \sum_{s'_1} \langle p_3 s_3; p_4 s_4 | \bar{j}(0) | p_1 s'_1 \rangle_c \langle p_1 s'_1 | A_0^a(0) | p_1 s_1 \rangle u(p_2 s_2) \\ & + \frac{m_\pi^2 M}{p_{40}} \sum_{s'_4} \langle p_4 s_4 | A_0^a(0) | p_4 s'_4 \rangle \langle p_3 s_3; p_4 s'_4 | \bar{j}(0) | p_1 s_1 \rangle_c u(p_2 s_2) \\ & - \frac{m_\pi^2 M}{p_{30}} \sum_{s'_3} \langle p_3 s_3 | A_0^a(0) | p_3 s'_3 \rangle \langle p_3 s'_3; p_4 s_4 | \bar{j}(0) | p_1 s_1 \rangle_c u(p_2 s_2), \end{aligned} \quad (\text{II.11a})$$

$$\begin{aligned} F(0) = & -\frac{m_\pi^2 M}{p_{20}} \sum_{s'_2} \langle \bar{d} | \bar{j}(0) | p_1 s_1 \rangle_c u(p_2 s'_2) \langle p_2 s'_2 | A_0^a(0) | p_2 s_2 \rangle \\ & + \frac{m_\pi^2 M}{p_{10}} \sum_{s'_1} \langle \bar{d} | \bar{j}(0) | p_1 s'_1 \rangle_c \langle p_1 s'_1 | A_0^a(0) | p_1 s_1 \rangle u(p_2 s_2). \end{aligned} \quad (\text{II.12a})$$

Thus, we have obtained the soft-pion ( $q_0 = 0$ ) production amplitude. As stated earlier this amplitude differs from the previous soft-pion production amplitudes in which the two-nucleon interaction was described by an on-shell amplitude.<sup>14</sup>

$F(0)$  will be useful when we take the nonrelativistic limit of the production amplitude (Sec. III). However, first we must obtain an expression for  $F(q_0)$  for arbitrary  $q_0$ . To write a general expression for  $F(q_0)$  we

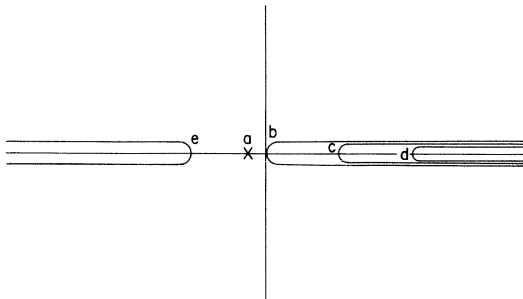

FIG. 4.  $q_0$  plane for  $NN \rightarrow NN\pi$ . The letters labeling the pole and cuts correspond to the graphs of Fig. 3.

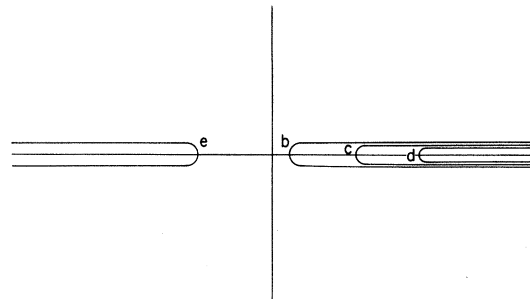

FIG. 5.  $q_0$  plane for  $NN \rightarrow d\pi$ . The letters labeling the cuts correspond to the graphs of Fig. 3.

return to Eq. (II.2). Taking  $(\square + m_\pi^2)$  inside the time-ordered product we obtain

$$F(q_0) = \int d^4x \langle f | [j_a^\pi(x), \bar{j}(0)] \theta(x_0) e^{iq_0 x_0} | p_1 s_1 \rangle u(p_2 s_2) + \int d^4x \langle f | [\dot{D}_a(x), \bar{j}(0)] \delta(x_0) e^{iq_0 x_0} | p_1 s_1 \rangle u(p_2 s_2) - iq_0 \int d^4x \langle f | [D_a(x), \bar{j}(0)] \delta(x_0) e^{iq_0 x_0} | p_1 s_1 \rangle u(p_2 s_2) , \quad (\text{II.20})$$

where

$$(\square + m_\pi^2) D_a(x) = j_a^\pi(x) .$$

The commutator  $[D_a(x), \bar{j}(0)] \delta(x_0)$  will vanish if the Lagrangian contains no coupling between the nucleon field and derivatives of the pion field. An example of such a Lagrangian satisfying this condition, as well as all other conditions we have assumed, is the Lagrangian of the  $\sigma$  model.<sup>15</sup> We will assume  $[D_a(x), \bar{j}(0)] \delta(x_0) = 0$  and discuss the consequences of this commutator being nonzero in Appendix B.

Integrating over  $x_0$  in (II.20), we obtain

$$F(q_0) = i \sum_n \int d^3 \vec{x} \frac{\langle f | j_a^\pi(0, \vec{x}) | n \rangle \langle n | \bar{j}(0) | p_1 s_1 \rangle}{q_0 + p_{f0} - n_0 + i\epsilon} u(p_2 s_2) - i \sum_n \int d^3 \vec{x} \frac{\langle f | \bar{j}(0) | n \rangle \langle n | j_a^\pi(0, \vec{x}) | p_1 s_1 \rangle}{q_0 + n_0 - p_{10} + i\epsilon} u(p_2 s_2) + \int d^3 \vec{x} \langle f | [\dot{D}_a(0, \vec{x}), \bar{j}(0)] | p_1 s_1 \rangle u(p_2 s_2) . \quad (\text{II.21})$$

Since the entire  $q_0$  dependence of  $F(q_0)$  is in the denominator, we see at once

$$F(\infty) = \int d^3 \vec{x} \langle f | [\dot{D}_a(0, \vec{x}), \bar{j}(0)] | p_1 s_1 \rangle u(p_2 s_2) . \quad (\text{II.22})$$

Unfortunately, this ETCR cannot be evaluated directly.

The first term in (II.21) contains amplitudes with intermediate states of baryon number two, some of which are represented in Figs. 3(a)–3(d). Except for Fig. 3(a), each term produces a cut in the  $q_0$  plane along the real positive axis. As stated previously the two-nucleon cut [Fig. 3(b)] begins at  $q_0 = 0$ . The two-nucleon- $x$ -pion cuts ( $x = 1, 2, 3, \dots$ ) begin at approximately  $q_0 = xm_\pi$ .

Since  $\langle p_1 | j^\pi(0) | p_1 \rangle$  vanishes by parity arguments, no one-nucleon pole term is introduced by the second term in (II.21). The lowest-mass intermediate state is  $n =$  one pion and one nucleon. This state gives rise to a left-hand cut which begins at approximately  $q_0 = -m_\pi$ . This term is illustrated in Fig. 3(e).

Figure 4 illustrates the low-lying poles and cuts in the  $q_0$  plane for two nucleons in the final state. Figure 5 does the same for a deuteron in the final state.

### III. CONNECTION WITH NONRELATIVISTIC DISTORTED-WAVE THEORY

For a first approximation we assume that all cuts except the two-nucleon cut are negligible. Then  $F(q_0)$  can be written

$$F(q_0) = F(\infty) + i \sum_{n_2, n_2} \frac{\langle p_3 s_3; p_4 s_4 | j_a^\pi(0) | n_1 n_2 \rangle_{i_n} \langle n_1 n_2 | \bar{j}(0) | p_1 s_1 \rangle u(p_2 s_2)}{p_{40} + p_{30} + q_0 - p_n + i\epsilon} (2\pi)^3 \delta^{(3)}(\vec{p}_3 + \vec{p}_4 - \vec{p}_n) , \quad (\text{III.1})$$

where the states  $n_1$  and  $n_2$  are nucleons and  $p_n = p_{n_1} + p_{n_2}$ . (We discuss the case when the two nucleons in the final state are unbound. However, the following argument holds equally well for a deuteron final state.) The center-of-mass three-momentum of the intermediate nucleons is fixed by the  $\delta$  function in (III.1). Thus, the free sum will be over the relative momentum and spin variables only.

We wish to recast (III.1) into a form more suggestive of nonrelativistic theory. Therefore, we introduce an "off-energy-shell function"  $\phi_{\alpha'}^{(+)}(E)$  defined by

$$\phi_{\alpha'}^{(+)}(E) = \chi_{\alpha'} + \frac{1}{E - K - U + i\epsilon} U \chi_{\alpha'} ,$$

where  $\chi_{\alpha'}$  is the two-nucleon plane-wave state,  $E$  is the total propagation energy of the two-nucleon system,  $K$  is kinetic-energy operator, and  $U$  is a nonrelativistic potential defined by

$$(2\pi)^3 \delta^{(3)}(\vec{p}_n - \vec{p}_1 - \vec{p}_2)_{i_n} \langle n_1 n_2 | \bar{j}(0) | p_1 s_1 \rangle u(p_2 s_2) = (\phi_{\alpha'}^{(+)} | U | \chi_{\alpha'}) . \quad (\text{III.2})$$

$\phi_{\alpha}(E)$  is a general vector which describes the two-nucleon system with momentum  $\vec{p}_{\alpha}$  and propagation energy  $E$ .  $\phi_{\alpha}(E_{\alpha'})$ , where  $|\vec{p}_{\alpha'}|^2 = 2ME_{\alpha'}$ , is the usual (on-shell) scattering solution, and  $\phi_{\alpha}(E)$  is the general off-energy-shell scattering solution. For convenience we will use  $\phi_{\alpha} \equiv \phi_{\alpha}(E_{\alpha'})$ .

Next we define a nonrelativistic potential  $V$  by

$$i(2\pi)^3 \delta^{(3)}(\vec{p}_3 + \vec{p}_4 - \vec{p}_n)_{\text{out}} \langle p_3 s_3; p_4 s_4 | j_a^\pi(0) | n_1 n_2 \rangle_{\text{in}} = (\phi_B^{(-)} | [V, c] | \phi_{\alpha'}^{(+)}), \quad (\text{III.3})$$

where  $\phi_B^{(-)}$  is the total outgoing two-nucleon wave function and  $c^\dagger$  is the pion creation operator for a pion at rest. (The operator  $[V, c]$  is just the nonrelativistic limit of the current operator for a pion at rest.)

To obtain the usual form for the nonrelativistic amplitude we multiply (III.1) by a three-momentum-conserving  $\delta$  function. Then we will be studying the expression

$$\begin{aligned} (2\pi)^3 \delta^{(3)}(\vec{p}_3 + \vec{p}_4 - \vec{p}_1 - \vec{p}_2) F(q_0) &= (2\pi)^3 \delta^{(3)}(\vec{p}_3 + \vec{p}_4 - \vec{p}_1 - \vec{p}_2) F(\infty) \\ &+ i \sum_{n_1 n_2} \frac{\langle p_3 s_3; p_4 s_4 | j_a^\pi(0) | n_1 n_2 \rangle_{\text{in}} \langle n_1 n_2 | \bar{j}^\pi(0) | p_1 s_1 \rangle u(p_2 s_2)}{p_{30} + p_{40} + q_0 - p_{n0} + i\epsilon} \\ &\times (2\pi)^6 \delta^{(3)}(\vec{p}_3 + \vec{p}_4 - \vec{p}_1 - \vec{p}_2) \delta^{(3)}(\vec{p}_3 + \vec{p}_4 - \vec{p}_n). \end{aligned} \quad (\text{III.1a})$$

Noting that we can replace  $\vec{p}_3 + \vec{p}_4$  with  $\vec{p}_n$  in the first  $\delta$  function, we insert (III.2) and (III.3) into (III.1a) and obtain

$$\begin{aligned} (2\pi)^3 \delta^{(3)}(\vec{p}_3 + \vec{p}_4 - \vec{p}_1 - \vec{p}_2) F(q_0) &= (2\pi)^3 \delta^{(3)}(\vec{p}_3 + \vec{p}_4 - \vec{p}_1 - \vec{p}_2) F(\infty) + \sum_{\alpha'} \frac{(\phi_B^{(-)} | [V, c] | \phi_{\alpha'}^{(+)})(\phi_{\alpha'}^{(+)} | U | \chi_\alpha)}{p_{30} + p_{40} + q_0 - p_{n0} + i\epsilon} \\ &= (2\pi)^3 \delta^{(3)}(\vec{p}_3 + \vec{p}_4 - \vec{p}_1 - \vec{p}_2) F(\infty) + \sum_{\alpha'} \frac{(\phi_B^{(-)} | [V, c] | \phi_{\alpha'}^{(+)})(\phi_{\alpha'}^{(+)} | U | \chi_\alpha)}{E - E_{\alpha'} + i\epsilon}, \end{aligned} \quad (\text{III.4})$$

where  $E + 2M \equiv p_{30} + p_{40} + q_0$ , and  $E_{\alpha'} + 2M \equiv p_{n0}$ . The point  $q_0 \equiv 0$  corresponds to  $E_0 + 2M \equiv p_{30} + p_{40}$ .

The energy variable  $E$  is more convenient to use than the mass variable  $q_0$ . Therefore, we define a function of  $E$ ,  $T_\alpha(E)$ , by the relations

$$\begin{aligned} T_\alpha(E) &= F(E + 2M - p_{30} - p_{40}) (2\pi)^3 \delta^{(3)}(\vec{p}_3 + \vec{p}_4 - \vec{p}_1 - \vec{p}_2) \\ &= F(q_0) (2\pi)^3 \delta^{(3)}(\vec{p}_3 + \vec{p}_4 - \vec{p}_1 - \vec{p}_2), \end{aligned}$$

where the subscript  $\alpha$  refers to the momentum of the incoming state. Thus,

$$\begin{aligned} T_\alpha(E) &= (2\pi)^3 \delta^{(3)}(\vec{p}_3 + \vec{p}_4 - \vec{p}_1 - \vec{p}_2) F(\infty) + \sum_{\alpha'} (\phi_B^{(-)} | [V, c] | \phi_{\alpha'}^{(+)})(\phi_{\alpha'}^{(+)} \left| \frac{1}{E - K - U + i\epsilon} U \right| \chi_\alpha) \\ &= (2\pi)^3 \delta^{(3)}(\vec{p}_3 + \vec{p}_4 - \vec{p}_1 - \vec{p}_2) F(\infty) + \left( \phi_B^{(-)} \left| [V, c] \frac{1}{E - K - U + i\epsilon} U \right| \chi_\alpha \right) \\ &= (2\pi)^3 \delta^{(3)}(\vec{p}_3 + \vec{p}_4 - \vec{p}_1 - \vec{p}_2) F(\infty) + (\phi_B^{(-)} | [V, c] | \phi_{\alpha'}^{(+)}(E)) - (\phi_B^{(-)} | [V, c] | \chi_\alpha). \end{aligned} \quad (\text{III.5})$$

Since  $F(m_\pi)$  is the physical production amplitude, we can write

$$\begin{aligned} (2\pi)^3 \delta^{(3)}(\vec{p}_3 + \vec{p}_4 - \vec{p}_1 - \vec{p}_2) F(m_\pi) &= (2\pi)^3 \delta^{(3)}(\vec{p}_3 + \vec{p}_4 - \vec{p}_1 - \vec{p}_2)_{\text{out}} \langle p_3 s_3; p_4 s_4 | j_a^\pi(0) | p_1 s_1; p_2 s_2 \rangle_{\text{in}} \\ &= (\phi_B^{(-)} | [V, c] | \phi_{\alpha'}^{(+)}(E_1)) = T_\alpha(E_1), \end{aligned} \quad (\text{III.6})$$

where  $E_1 \equiv m_\pi + p_{f0} - 2M$ .

Since all the  $E$  dependence of (III.5) is shown explicitly in  $\phi_{\alpha'}^{(+)}(E)$ , we set  $E = E_1$  in (III.5) and see immediately that

$$F(\infty) = (\phi_B^{(-)} | [V, c] | \chi_\alpha) (2\pi)^3 \delta^{(3)}(\vec{p}_3 + \vec{p}_4 - \vec{p}_1 - \vec{p}_2). \quad (\text{III.7})$$

Combining (III.5)–(III.7) we obtain

$$\begin{aligned} T_\alpha(E) &= (\phi_B^{(-)} | [V, c] | \phi_{\alpha'}^{(+)}(E)) \\ &= (\phi_B^{(-)} | [V, c] | \chi_\alpha) + \left( \phi_B^{(-)} \left| [V, c] \frac{1}{E - K + U + i\epsilon} U \right| \chi_\alpha \right). \end{aligned} \quad (\text{III.8})$$

The main content of (III.8) is to show that the entire  $q_0$  dependence of  $F(q_0)$  is contained in the  $E = q_0 + p_{f0} - 2M$  dependence of  $\phi_{\alpha'}^{(+)}(E)$ . We note in passing that  $F(\infty)$  plays the role of the matrix element of a nonrelativistic potential. [See (C6) in Appendix C.]

From (II.11) and (II.12) we know the value of  $T(E)$  at the (off-shell) energy,  $E_0$ . Now, we establish the connection between the physical production amplitude,  $T_\alpha(E_1 = m_\pi + p_{f0} - 2M)$  and  $T_\alpha(E_0 = p_{f0} - 2M)$ . Equa-

tion (III.8) may be written as

$$\begin{aligned} T_{\alpha}(E) &= \left( \phi_{\beta}^{(-)} \left| [V, c] \frac{1}{E_0 - K - U} (E_0 - K) \frac{1}{E_0 - K} (E_0 - K - U) \right| \phi_{\alpha}^{(+)}(E) \right), \\ &= \sum_{\alpha'} \left( \phi_{\beta}^{(-)} \left| [V, c] \frac{1}{E_0 - K - U} (E_0 - K) \right| \chi_{\alpha'} \right) \left( \chi_{\alpha'} \left| \frac{1}{E_0 - K} (E_0 - E) \right| \phi_{\alpha}^{(+)}(E) \right), \end{aligned} \quad (\text{III.9})$$

where  $(K+U)\phi_{\alpha}^{(+)}(E) = E\phi_{\alpha}^{(+)}(E)$  has been used. (All factors of  $E_0$  contain a small positive imaginary part.)

Noting that  $E_0 - E_1 = -m_{\pi}$ , and

$$\phi_{\alpha'}^{(+)}(E_0) = \frac{1}{E_0 - K - U} (E_0 - K) \chi_{\alpha'},$$

we can write

$$\begin{aligned} T_{\alpha}(E_1) &= \sum_{\alpha'} \left( \phi_{\beta}^{(-)} \left| [V, c] \right| \phi_{\alpha'}^{(+)}(E_0) \right) \left( \chi_{\alpha'} \left| \frac{-m_{\pi}}{E_0 - K} \right| \phi_{\alpha}^{(+)}(E_1) \right), \\ &= \sum_{\alpha'} T_{\alpha'} \left( \chi_{\alpha'} \left| \frac{-m_{\pi}}{E_0 - K} \right| \phi_{\alpha}^{(+)}(E_1) \right). \end{aligned} \quad (\text{III.10})$$

The first factor in (III.10) is the value of  $T_{\alpha}(E)$  corresponding to the energy (mass) at which we can evaluate the relativistic result. However, we must know  $T_{\alpha'}(E_0)$  for arbitrary values of the incoming relative momentum,  $\vec{p}_{\alpha'}$ . In Sec. II we evaluated  $F(q_0)$  by fixing the incoming momenta through the relation  $p_3 + p_4 + k = p_1 + p_2$  and  $k = (m_{\pi}, 0, 0, 0)$ . The space components fix the center-of-mass three-momentum while the time component fixes the energy and thus the relative three-momentum. Therefore, allowing  $k_0$  to vary while restricting  $\vec{k}$  to be zero would allow us to determine  $F(q_0)$  for arbitrary values of the relative three-momentum while holding the center-of-mass three-momentum fixed. This procedure would allow us to determine the first factor in (III.10).

Since the momentum-conservation relation was used to arrive at (II.11a), we must determine what error is involved if  $k_0$  is allowed to vary. For  $k = (k_0, 0, 0, 0)$ , where  $k_0$  is arbitrary, (II.16) becomes

$$- \sum_{s_2'} \left[ u(p_2 s_2') \bar{u}(p_2 s_2') \gamma_0 \gamma_3 u(p_2 s_2) \frac{2M}{2p_{20} - k_0} - \frac{k_0}{2p_{20} - k_0} v(p_2 s_2') \bar{v}(p_2 s_2') \gamma_3 u(p_2 s_2) \right]. \quad (\text{II.16a})$$

From (II.16a) we see that as long as  $k_0$  does not differ appreciably from  $m_{\pi}$  all approximations leading to (II.11a) will be valid. To make this statement more precise compare the two equations:

$$\begin{aligned} k_0 &= |\vec{P}|^2/4M + |\vec{p}_{\alpha'}|^2/M - p_{f_0}, \\ m_{\pi} &= |\vec{P}|^2/4M + |\vec{p}_{\alpha}|^2/M - p_{f_0}, \end{aligned} \quad (\text{III.11})$$

where  $\vec{P}$  is the center-of-mass momentum of the incoming two nucleons. Equations (III.11) yield

$$k_0 - m_{\pi} = (|\vec{p}_{\alpha'}|^2 - |\vec{p}_{\alpha}|^2)/M.$$

Thus, as long as  $|\vec{p}_{\alpha'} - \vec{p}_{\alpha}| \ll M$ ,  $k_0$  will be approximately equal to  $m_{\pi}$  and we may use (II.11a) to evaluate (III.10). When  $|\vec{p}_{\alpha'} - \vec{p}_{\alpha}|$  does become large compared to  $M$ , the energy denominator in the second term of (III.10) will be large, and, thus, contributions from such terms will be small. Therefore, we will use (II.11a) to evaluate the first term in (III.10).

We note in passing that the second term in (III.10) simply boosts the amplitude from the off-shell energy  $E_0$  to the physical value  $E_1$ .

To evaluate the nonrelativistic limits of (II.11a) and (II.12a) we recall that  $\langle p_1 s' | A_0^a(0) | p_1 s_1 \rangle$  nonrelativistically becomes

$$-g_A \left( \chi_1' \left| i \frac{\vec{\sigma} \cdot \vec{\nabla}}{M} \frac{1}{2} \tau^a \right| \chi_1 \right), \quad (\text{III.12})$$

where  $g_A$  is the axial-vector coupling constant, and  $\vec{\nabla}$  operates on the one-nucleon plane-wave state  $\chi_1$ . As before,

$$\begin{aligned} \langle p_3 s_3; p_4 s_4 | \vec{f}(0) | p_1 s_1 \rangle u(p_2 s_2) &= i(\phi_{\beta}^{(-)} | U | \chi_{\alpha}) \\ &= i(\chi_{\beta} | \Omega^{(-)\dagger}(E_f) U | \chi_{\alpha}) \end{aligned} \quad (\text{III.13})$$



where

$$\Omega^{(-)}(E) = 1 + \frac{1}{E - K - U - i\epsilon} U.$$

Using these identifications we obtain

$$T_\alpha(E_0) = -\frac{g_A m_\pi^2}{M} (\chi_\beta | \Omega^{(-)\dagger}(E_f) U (\vec{\sigma}_1 \cdot \vec{\nabla}_1 \frac{1}{2} \tau_1^a + \vec{\sigma}_2 \cdot \vec{\nabla}_2 \frac{1}{2} \tau_2^a) | \chi_\alpha) + \frac{g_A m_\pi^2}{M} (\chi_\beta | [\vec{\sigma}_3 \cdot \vec{\nabla}_3 \frac{1}{2} \tau_3^a + \vec{\sigma}_4 \cdot \vec{\nabla}_4 \frac{1}{2} \tau_4^a] \Omega^{(-)\dagger}(E_f) U | \chi_\alpha). \quad (\text{III.14})$$

Operators subscripted 1 and 2 act to the right, and those subscripted 3 and 4 act to the left.

Inserting (III.14) into (III.10) and summing over  $\alpha'$ , we obtain

$$T_\alpha(E) = -m_\pi^2 g_A (\chi_\beta | \Omega^{(-)\dagger}(E_f) U \left[ \frac{\vec{\sigma}_1 \cdot \vec{\nabla}_1 \frac{1}{2} \tau_1^a + \vec{\sigma}_2 \cdot \vec{\nabla}_2 \frac{1}{2} \tau_2^a}{M} \right] \frac{-m_\pi}{E_0 - K} | \phi_\alpha^{(+)}(E)) \\ + m_\pi^2 g_A (\chi_\beta | \left[ \frac{\vec{\sigma}_3 \cdot \vec{\nabla}_3 \frac{1}{2} \tau_3^a + \vec{\sigma}_4 \cdot \vec{\nabla}_4 \frac{1}{2} \tau_4^a}{M} \right] \Omega^{(-)\dagger}(E_f) U \frac{-m_\pi}{E_0 - K} | \phi_\alpha^{(+)}(E)). \quad (\text{III.15})$$

After a considerable amount of manipulating (see Appendix D),  $T_\alpha(E)$  may be written as

$$T_\alpha(E) = -i g_A (\chi_\beta | t^{(+)}(E_0) \frac{m_\pi^2}{E_0 - K + i\epsilon} \left[ \sum_{n=1}^2 i \frac{m_\pi}{M} \vec{\sigma}_n \cdot \vec{\nabla}_n \frac{1}{2} \tau_n^a \right] | \chi_\alpha) - i g_A (\chi_\beta | \frac{m_\pi^2}{E - K + i\epsilon} \left[ \sum_{n=3}^4 i \frac{m_\pi}{M} \vec{\sigma}_n \cdot \vec{\nabla}_n \frac{1}{2} \tau_n^a \right] t^{(+)}(E) | \chi_\alpha) \\ - i g_A (\chi_\beta | t^{(+)}(E_0) \frac{m_\pi^2}{E_0 - K + i\epsilon} \left[ \sum_{n=1}^2 i \frac{m_\pi}{M} \vec{\sigma}_n \cdot \vec{\nabla}_n \frac{1}{2} \tau_n^a \right] \frac{1}{E - K + i\epsilon} t^{(+)}(E) | \chi_\alpha), \quad (\text{III.16})$$

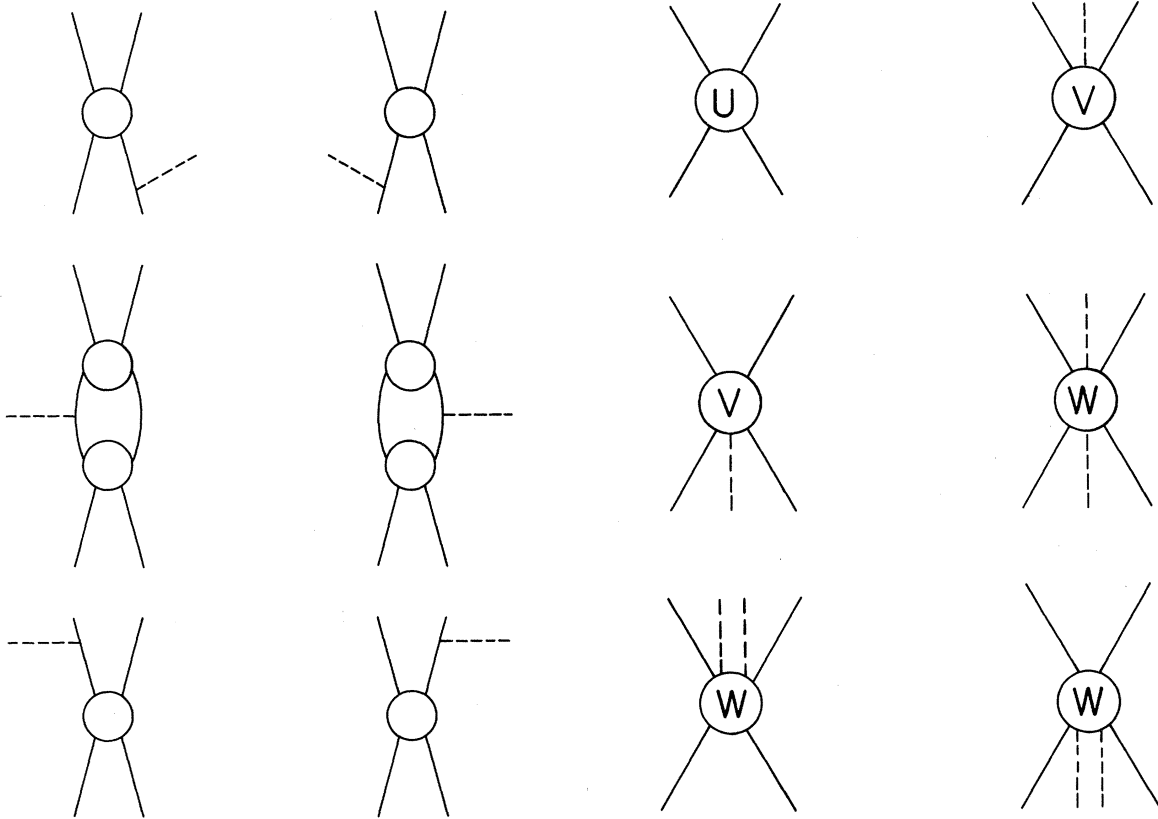

FIG. 6. Graphical description of  $T_\alpha(E)$  in the distorted-wave approximation.

FIG. 7. Graphical description of the potentials  $U$ ,  $V$ , and  $W$ .

where  $t(E)$  is the nucleon-nucleon  $t$  matrix at energy  $E$ . A graphical description of (III.16) is shown in Fig. 6. Those graphs represented emission from an external line are identical with Fig. 1 if the relativistic axial-vector coupling is replaced by its nonrelativistic equivalent. The remaining graphs of Fig. 6 represent the first-order terms of Fig. 3(b).

Using further manipulations similar to those of Appendix D, and inserting the normalization constant from (II.3) we can write (III.16) as

$$T_{NN \rightarrow NN\pi^a} = \frac{-ig_A m_\pi^2 \sqrt{2}}{f_\pi} \left( \phi_\beta^{(-)} \left| \sum_{n=1}^2 i \frac{m_\pi}{M} \vec{\sigma}_n \cdot \vec{\nabla}_n \frac{1}{2} \tau^a \right| \phi_\alpha^{(+)} \right). \quad (\text{III.17})$$

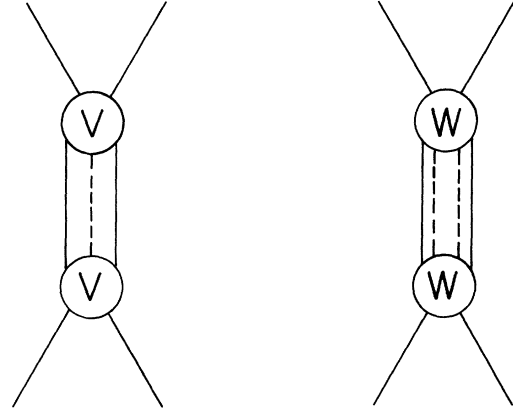

FIG. 8. Some contributions of the potential  $V$  and  $W$  to nucleon-nucleon elastic scattering.

Equation (III.17) has been derived by using two rather general results: the value of the production amplitude at  $q_0=0$  (the soft-pion limit) and the nonrelativistic connection between this limit and the physical nonrelativistic production amplitude. We have not needed to look at details of the nucleon-pion interaction. Further, this production amplitude, (III.17), indicates that the first-order correction to the soft-pion limit is that correction due to initial-state interactions of the two nucleons. This correction factor is evaluated much more easily in the nonrelativistic formalism than in the relativistic.

The derivation of (III.17) was performed in the rest frame of the pion. Thus, if we wish to evaluate (III.17) for pion production in an arbitrary frame, we would make a Lorentz transformation to the pion rest frame and evaluate (III.17). (Note that we began the derivation in Sec. II by transforming the *relativistic* amplitude to the pion rest frame.)

#### IV. CORRECTIONS TO THE DISTORTED-WAVE APPROXIMATION

In Sec. III we neglected all but the leading singularity in the mass dispersion relation and were led directly to the nonrelativistic distorted-wave approximation. This result seems to imply that a similar connection should exist between the remaining cuts in the mass dispersion relation and the corrections to the distorted-wave theory. We will establish this connection for the next two cuts in this section. Unfortunately, the situation is much more complex, and, therefore, this discussion must be more qualitative than the previous discussion.

First, we will review the nonrelativistic production theory in which the pion is allowed to interact with the final-state nucleons.  $U$  and  $V$  will be the potentials defined in Sec. II. A third potential,  $W$ , is defined as the two-pion-two-nucleon potential.  $W$  can scatter pions from the two-nucleon system, or it can create or absorb two pions in nucleon-nucleon collisions. The transitions produced by  $U$ ,  $V$ , and  $W$  are shown schematically in Fig. 7. At first,  $W$  might seem redundant, since iterations of  $V$  can produce two-pion-two-nucleon interactions. However, we recall that in pion-nucleon scattering, iterations of  $V$  cannot reproduce the correct  $s$ -wave scattering amplitude. To predict the correct amplitude a new potential related to exchange of a particle such as the  $\rho$  meson must be introduced. Thus, we think of  $W$  as the two-pion-two-nucleon potential analogous to the potential needed to obtain the low-energy pion-nucleon scattering results.

With these definitions the total Hamiltonian is  $H=K+U+V+W$ , and the total wave function is

$$\psi_\alpha^{(+)}(E) = \chi_\alpha + \frac{1}{E-K+i\epsilon} (U+V+W) \psi_\alpha^{(+)}(E), \quad (\text{IV.1})$$

where, as before,  $\chi_\alpha$  is the plane-wave state.

We note that, in addition to  $U$ , processes such as those shown in Fig. 8 contribute to the nucleon-nucleon elastic scattering. Therefore, we wish to define an effective potential  $\bar{U}$  as the potential that reproduces the nucleon-nucleon elastic scattering amplitude.<sup>16</sup> Then, the two-nucleon effective scattering wave function  $\bar{\phi}_\alpha^{(+)}$  will be given by

$$\bar{\phi}_\alpha^{(+)}(E) = \chi_\alpha + \frac{1}{E - K + i\epsilon} \bar{U} \bar{\phi}_\alpha^{(+)}(E) . \quad (\text{IV.2})$$

To determine  $\bar{U}$  we define an operator  $Q$  by

$$\psi_\alpha^{(+)}(E) = Q \bar{\phi}_\alpha^{(+)}(E) , \quad (\text{IV.3})$$

and an operator  $\Lambda_0$  which projects the two-nucleon state  $\bar{\phi}_\alpha^{(+)}$  from  $\psi_\alpha^{(+)}$ .

By the definition of  $\bar{U}$  and  $\bar{\phi}_\alpha(E)$  the amplitude for nucleon-nucleon elastic scattering is

$$T_\alpha^{\text{elastic}}(E) = (\chi_\beta | \bar{U} | \bar{\phi}_\alpha^{(+)}(E)) . \quad (\text{IV.4})$$

The total amplitude for a transition from state  $\alpha$  to state  $\beta$  is given by

$$T_{\beta\alpha}(E) = (\chi_\beta | (U + V + W) | \psi_\alpha^{(+)}(E)) \quad (\text{IV.5})$$

$$= (\chi_\beta | \Lambda_0 (U + V + W) Q | \bar{\phi}_\alpha^{(+)}(E)) + (\chi_\beta | (1 - \Lambda_0) (U + V + W) Q | \bar{\phi}_\alpha^{(+)}(E)) . \quad (\text{IV.6})$$

Since the first term in (IV.6) is the elastic scattering amplitude, it may be compared with (IV.4) to obtain

$$\bar{U} = \Lambda_0 (U + V + W) Q . \quad (\text{IV.7})$$

To determine an equation for  $Q$  we write (IV.1) as

$$\begin{aligned} \psi_\alpha^{(+)}(E) &= \chi_\alpha + \frac{1}{E - K + i\epsilon} (U + V + W) Q \bar{\phi}_\alpha^{(+)}(E) \\ &= \chi_\alpha + \frac{1}{E - K + i\epsilon} (1 - \Lambda_0) (U + V + W) Q \bar{\phi}_\alpha^{(+)}(E) + \frac{1}{E - K + i\epsilon} \Lambda_0 (U + V + W) Q \bar{\phi}_\alpha^{(+)}(E) . \end{aligned} \quad (\text{IV.8})$$

Using (IV.2) and (IV.7) we see that  $Q$  must obey the relation

$$Q = 1 + \frac{1}{E - K + i\epsilon} (1 - \Lambda_0) (U + V + W) Q . \quad (\text{IV.9})$$

If (IV.9) is inserted into (IV.7) an infinite series for  $\bar{U}$  is obtained.

$$\bar{U} = \Lambda_0 (U + V + W) + \Lambda_0 (U + V + W) \frac{1}{E - K + i\epsilon} (1 - \Lambda_0) (U + V + W) + \dots . \quad (\text{IV.10})$$

Thus,  $\psi_\alpha^{(+)}(E)$  may be written

$$\begin{aligned} \psi_\alpha^{(+)}(E) &= \bar{\phi}_\alpha^{(+)}(E) + \frac{1}{E - H + i\epsilon} [(U - \bar{U}) + V + W] \bar{\phi}_\alpha^{(+)}(E) \\ &= \bar{\phi}_\alpha^{(+)}(E) + \frac{1}{E - H + i\epsilon} (1 - \Lambda_0) (U + V + W) \bar{\phi}_\alpha^{(+)}(E) + \dots . \end{aligned} \quad (\text{IV.11})$$

The total nonrelativistic single-pion production amplitude can be written as (see Appendix C)

$$T_\alpha(E) = (\bar{\phi}_\beta^{(-)} | [(U + V + W - \bar{U}), c] | \psi_\alpha^{(+)}(E)) . \quad (\text{IV.12})$$

If we retain only the first term in (IV.10), (IV.12) becomes

$$T_\alpha(E) = (\bar{\phi}_\beta^{(-)} | (1 - \Lambda_0) [(U + V + W), c] | \psi_\alpha^{(+)}(E)) . \quad (\text{IV.13})$$

If we truncate (IV.11) after the second term in the series and place that result in (IV.13), we have

$$T_\alpha(E) = (\bar{\phi}_\beta^{(-)} | (1 - \Lambda_0) [(U + V + W), c] | \bar{\phi}_\alpha^{(+)}(E)) + (\bar{\phi}_\beta^{(-)} | (1 - \Lambda_0) [(U + V + W), c] \frac{1}{E - H + i\epsilon} (1 - \Lambda_0) (U + V + W) | \bar{\phi}_\alpha^{(+)}(E)) . \quad (\text{IV.14})$$

Only  $V$  will contribute in the first term. Since the projection operator  $(1 - \Lambda_0)$  will be redundant in this term, we can drop it. Then, the first term in (IV.14) becomes

$$(\bar{\phi}_\beta^{(-)} | [V, c] | \bar{\phi}_\alpha^{(+)}(E)) .$$

In the second term of (IV.14) we introduce a complete set of intermediate states  $\Psi_{\alpha'}$  and obtain

$$\sum_{\alpha'} (\bar{\phi}_\beta^{(-)} | (1 - \Lambda_0) [(U + V + W), c] | \Psi_{\alpha'}) (\Psi_{\alpha'} | (1 - \Lambda_0) (U + V + W) | \bar{\phi}_\alpha^{(+)}(E)) . \quad (\text{IV.15})$$

In the second factor the matrix element  $(\Psi_{\alpha'} | (1 - \Lambda_0) U | \bar{\phi}_\alpha^{(+)})$  vanishes, while the term containing  $V$  connects

only to the one-pion-two-nucleon state, and the term containing  $W$  connects only to the two-pion-two-nucleon state. Defining  $\psi_{1\alpha'}$  and  $\psi_{2\alpha'}$  to be these two states, (IV.15) becomes

$$\sum_{\alpha'} (\bar{\phi}_B^{(-)} | (1 - \Lambda_0) [(U + V + W), c] | \psi_{1\alpha'}^{(+)} ) (\psi_{1\alpha'}^{(+)} | V | \bar{\phi}_\alpha^{(+)}(E) ) \frac{1}{E - E_{\alpha'} + i\epsilon} \quad (\text{IV.16a})$$

$$+ \sum_{\alpha'} (\bar{\phi}_B^{(-)} | (1 - \Lambda_0) [(U + V + W), c] | \psi_{2\alpha'}^{(+)} ) (\psi_{2\alpha'}^{(+)} | W | \bar{\phi}_\alpha^{(+)}(E) ) \frac{1}{E - E_{\alpha'} + i\epsilon} . \quad (\text{IV.16b})$$

Only  $W$  will contribute to the first factor in (IV.16a), and  $V$  will be the only nonvanishing element in the first factor of (IV.16b).

Collecting the above information, (IV.14) can be written

$$T_\alpha(E) = (\bar{\phi}_B^{(-)} | [V, c] | \bar{\phi}_\alpha^{(+)}(E) ) + \sum_{\alpha'} (\bar{\phi}_B^{(-)} | [W, c] | \psi_{1\alpha'}^{(+)} ) (\psi_{1\alpha'}^{(+)} | V | \bar{\phi}_\alpha^{(+)}(E) ) \frac{1}{E - E_{\alpha'} + i\epsilon} \\ + \sum_{\alpha'} (\bar{\phi}_B^{(-)} | [V, c] | \psi_{2\alpha'}^{(+)} ) (\psi_{2\alpha'}^{(+)} | W | \bar{\phi}_\alpha^{(+)}(E) ) \frac{1}{E - E_{\alpha'} + i\epsilon} . \quad (\text{IV.17})$$

The three leading terms of the nonrelativistic amplitude are given by (IV.17). We wish to compare this result with (II.21), which is rewritten here for reference:

$$F(q_0) = F(\infty) + i \sum_n \frac{\langle f | j_a^\pi(0) | n \rangle \langle n | \bar{j}^\pi(0) | p_1 s_1 \rangle u(p_2 s_2)}{p_{f_0} - q_0 - p_{n_0} + i\epsilon} (2\pi)^3 \delta^{(3)}(\vec{p}_f - \vec{p}_n) \\ - \sum_n \frac{\langle f | \bar{j}^\pi(0) | n \rangle \langle n | j_a^\pi(0) | p_1 s_1 \rangle u(p_2 s_2)}{p_{n_0} + q_0 - p_{1_0} + i\epsilon} (2\pi)^3 \delta^{(3)}(\vec{p}_n - \vec{p}_1) . \quad (\text{II.21})$$

Relating the  $E$  dependence of (IV.17) with the  $q_0$  dependence of (II.21) as we did in Sec. III (i.e.,  $E \equiv p_{f_0} + q_0 - 2M$ ), we see that

$$F(\infty) = (\bar{\phi}_B^{(-)} | [V, c] | \chi_\alpha ) ,$$

as in Sec. III. If we use  $E_{\alpha'} \equiv p_{n_0} - 2M$  as in Sec. III, we find that the second term in (IV.17) has a cut beginning at the same value of  $q_0$  as the cut corresponding to the two-nucleon-one-pion intermediate state in the second term of (II.21). This process is shown in Fig. 3(c) and corresponds to cut c in Fig. 4.

Likewise, the process shown in Fig. 3(d) corresponds to the connected part of the third term in (IV.17).

Although the relation between the left-hand cuts and the nonrelativistic amplitude is not as transparent as the above discussion, we note that, if one of the intermediate pions in the last term in (IV.17) is also the final pion, the process is the same as that shown in Fig. 3(e). Thus, the cut e in Fig. 4 corresponds to a disconnected part of the last term of the nonrelativistic amplitude, (IV.17).

In this section we have been able to show a connection between the corrections to the distorted-wave theory and the cuts in the pion-mass dispersion approach. These correction terms have proven to be very important in phenomenological calculations of pion production processes. For example, in production processes at threshold Koltun and Reitan<sup>17</sup> have studied the subset of these amplitudes shown in Fig. 9. They found the contributions of these processes to be much larger than the distorted-wave approximation for the process  $p + p \rightarrow d + \pi^+$ . Using an improved phenomenological Hamiltonian, Reitan<sup>18</sup> has obtained a

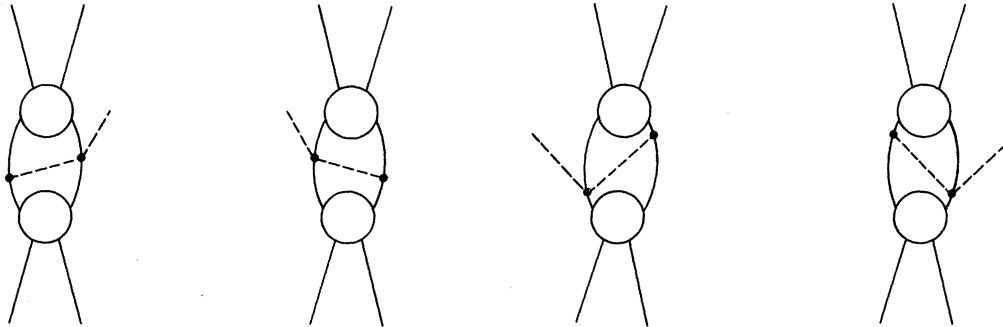

FIG. 9. Corrections to the distorted-wave approximation for  $NN \rightarrow d\pi$  at threshold (following Ref. 16).

total cross section within 20% of the experimental value. For laboratory kinetic energies from slightly above threshold to about 650 MeV, Mandelstam<sup>19</sup> has shown that the second term of (IV.14) dominates the amplitude when  $W$  is approximated by assuming the  $\pi$ - $N$  scattering proceeds through a (3, 3)-resonance intermediate state.

### V. CONCLUSIONS

In this study we have obtained the amplitude for pion production in nucleon-nucleon collisions by using two rather general results: (i) the value of the relativistic production amplitude at the soft-pion limit and (ii) the nonrelativistic operator which "boosts" the corresponding nonrelativistic amplitude to the physical energy from the off-shell energy,  $q_0=0$ . We did not need to consider the details of the pion-nucleon interaction. The use of nonrelativistic theory allows us to use well-known wave functions for the nucleon-nucleon distorted-wave correction to the soft-pion limit rather than attempt to estimate the corrections in terms of relativistic interactions.<sup>20</sup> Further, we have shown that the lowest-order corrections to the distorted-wave theory are very similar to those treated in earlier studies of this process. Since the results of this paper depend on the off-energy-shell nucleon-nucleon interaction, we will discuss what can be learned about this off-shell interaction by studying pion production in a future paper.

### ACKNOWLEDGMENT

One of us (C.A.L.) would like to acknowledge the hospitality of the Aspen Center for Physics during the summer of 1969.

### APPENDIX A.

We define the following:

$$Q_5^a(x_0) = \int A_5^a(x) d^3x, \quad (\text{A1})$$

$$Q^a(x_0) = \int V_5^a(x) d^3x, \quad (\text{A2})$$

where  $V_5^a(x)$  is the time component of the vector current.

We assume the ETCR

$$[Q_5^a(y_0), \bar{\psi}(y)] = -\bar{\psi}(y) \gamma_5 \frac{1}{2} \tau^a. \quad (\text{A3})$$

Applying  $(-i\not{V}_y - M)$  on the right of (A3) we obtain

$$[Q_5^a(y_0), \bar{f}(y)] = [\bar{f}(y) + 2M\bar{\psi}(y)] \gamma_5 \frac{1}{2} \tau^a + i \int d^3x [D_a(y_0, \vec{x}), \bar{\psi}(y)] \gamma_0. \quad (\text{A4})$$

To evaluate the ETCR on the right side of (A4) we note that

$$i\epsilon_{abc} [Q^c(y_0), \bar{f}(y)] = i\epsilon_{abc} \bar{f}(y) \frac{1}{2} \tau^c. \quad (\text{A5})$$

Using the usual  $SU2 \times SU2$  ETCR's we may write (A5) as

$$[[Q_5^a(y_0), Q_5^b(y_0)], \bar{f}(y)] = i\epsilon_{abc} \bar{f}(y) \frac{1}{2} \tau^c. \quad (\text{A6})$$

We use Jacobi's identity to write (A6) as

$$[Q_5^a(y_0), [Q_5^b(y_0), \bar{f}(y)]] - [Q_5^b(y_0), [Q_5^a(y_0), \bar{f}(y)]] = i\epsilon_{abc} \bar{f}(y) \frac{1}{2} \tau^c. \quad (\text{A7})$$

Since the two terms of the left side of (A7) differ only by the interchange of  $a$  and  $b$ , we study the first one:

$$[Q_5^a(y_0), [Q_5^b(y_0), \bar{f}(y)]] = [Q_5^a(y_0), [\bar{f}(y) + 2M\bar{\psi}(y)] \gamma_5 \frac{1}{2} \tau^b] + i [Q_5^a(y_0), \int d^3x [D_a(y_0, \vec{x}), \bar{\psi}(y)]] \quad (\text{A8})$$

$$= \bar{f}(y) \frac{1}{4} \tau^a \tau^b + i \int d^3x [D_a(y_0, \vec{x}), \bar{\psi}(y)] \gamma_5 \frac{1}{2} \tau^b + i [Q_5^a(y_0), \int d^3x [D_b(y_0, x), \bar{\psi}(y)]] \quad (\text{A9})$$

In obtaining (A9) we have used (A3) and (A4) several times. We rewrite the last term of (A9) using Jacobi's identity and obtain

$$\begin{aligned}
[Q_5^a(y_0), [Q_5^b(y_0), \bar{f}(y)]] &= \bar{f}(y) \frac{1}{4} \tau^a \tau^b + i \int d^3x [D_a(y_0, \vec{x}), \bar{\psi}(y)] \gamma_5 \frac{1}{2} \tau^b \\
&\quad - i \int d^3x [D_b(y_0, \vec{x}), [\bar{\psi}(y), Q_5^a(y_0)]] - i \int d^3x [\bar{\psi}(y), [Q_5^a(y_0), D_b(y_0, \vec{x})]] , \tag{A10}
\end{aligned}$$

$$\begin{aligned}
&= \bar{f}(y) \frac{1}{4} \tau^a \tau^b + i \int d^3x [D_a(y_0, \vec{x}), \bar{\psi}(y)] \gamma_5 \frac{1}{2} \tau^b \\
&\quad - i \int d^3x [D_b(y_0, \vec{x}), \bar{\psi}(y)] \gamma_5 \frac{1}{2} \tau^a + \int [\bar{\psi}(y), \sigma_{ab}(y_0, \vec{x})] d^3x , \tag{A11}
\end{aligned}$$

where  $\sigma_{ab}$  is the usual scalar operator. (Recall that  $\sigma_{ab}$  is symmetric in the isospin indices, and thus,  $\sigma_{ab} = \sigma_{ba}$ .)

Inserting (A11) into (A7) we obtain

$$i \epsilon_{abc} \bar{f}(y) \frac{1}{2} \tau^c + 2i \int d^3x [D_a(y_0, \vec{x}), \bar{\psi}(y)] \gamma_5 \frac{1}{2} \tau^b - 2i \int d^3x [D_b(y_0, \vec{x}), \bar{\psi}(y)] \gamma_5 \frac{1}{2} \tau^a = i \epsilon_{abc} \bar{f}(y) \frac{1}{2} \tau^c . \tag{A12}$$

Therefore,

$$\int d^3x [D_a(y_0, \vec{x}), \bar{\psi}(y)] = 0 \tag{A13}$$

and we have (in the notation of Sec. II)

$$\int d^3x [A_0^a(x), \bar{f}(y)] \delta(x_0 - y_0) = \bar{f}(y) + 2M \bar{\psi}(y) . \tag{A14}$$

#### APPENDIX B.

We define

$$\begin{aligned}
B^a &= \int \langle f | [\dot{D}_a(x), \bar{f}(0)] \delta(x_0) | p_1 s_1 \rangle u(p_2 s_2) d^4x , \\
C^a &= \int \langle f | [D_a(x), \bar{f}(0)] \delta(x_0) | p_1 s_1 \rangle u(p_2 s_2) d^4x .
\end{aligned} \tag{B1}$$

If  $C^a \neq 0$ , then (III.1) would be

$$F(q_0) = B^a - i q_0 C^a + i \sum_{\pi} \int \frac{\langle f | j_a^{\pi}(0, \vec{x}) | n \rangle \langle n | \bar{j}(0) | p_1 s_1 \rangle u(p_2 s_2)}{p_{f0} - n_0 + q_0 + i\epsilon} d^3x . \tag{B2}$$

Using (III.2) and (III.3), we obtain

$$T(E) = B^a - i q_0 C^a + (\phi_{\beta}^{(-)} | [V, c] | \phi_{\alpha}^{(+)}(E)) - (\phi_{\beta}^{(-)} | [V, c] | \chi_{\alpha}) . \tag{B3}$$

Setting  $E = E_1 = p_{f0} + m_{\pi} - 2M$ , (B3) implies

$$B^a - i m_{\pi} C^a = (\phi_{\beta}^{(-)} | [V, c] | \chi_{\alpha}) . \tag{B4}$$

Since  $q_0 = 0$  at  $E = E_0$ ,

$$T(E_0) = B^a + (\phi_{\beta}^{(-)} | [V, c] | \phi_{\alpha}^{(+)}(E_0)) - (\phi_{\beta}^{(-)} | [V, c] | \chi_{\alpha}) . \tag{B5}$$

Using (B4), (B5) becomes

$$T(E_0) = (\phi_{\beta}^{(-)} | [V, c] | \phi_{\alpha}^{(+)}(E_0)) + i m_{\pi} C^a = F(q_0 = 0) . \tag{B6}$$

Therefore,

$$(\phi_{\beta}^{(-)} | [V, c] | \phi_{\alpha}^{(+)}(E_0)) = F(0) - i m_{\pi} C^a . \tag{B7}$$

Comparing (B7) with (II.4) we see that we need to know the ETCR's

$$- \int d^4x m_{\pi}^2 [A_0^a(x), \bar{f}(0)] \delta(x_0) - i m_{\pi} \int d^4x [D_a(x), \bar{f}(0)] \delta(x_0) \tag{B8}$$

to determine

$$(\phi_{\beta}^{(-)} | [V, c] | \phi_{\alpha}^{(+)}(E)) .$$

For the results of Sec. III to hold the ETCR (B8) must be

$$\int d^4x [[m_{\pi} A_0^a(x) + iD_a(x)], \bar{j}(0)] \delta(x_0) = m_{\pi} [\bar{j}(0) + 2M\bar{\psi}(0)] \gamma_5 \frac{1}{2} \tau^a . \quad (\text{B9})$$

## APPENDIX C.

In this Appendix we review the nonrelativistic two-potential theory.<sup>21</sup> We will use the following definitions:

$U \equiv$  nucleon-nucleon scattering potential,  
 $V \equiv$  single-pion production potential,  
 $K \equiv$  kinetic-energy operator,  
 $H \equiv K + U + V$  .

We assume that once the pion is emitted, it does not interact with the nucleons.

If  $\Psi_{\alpha}^{(+)}(E)$  is the solution of the Schrödinger equation with the total Hamiltonian, then

$$\begin{aligned} \Psi_{\alpha}^{(+)}(E) &= \chi_{\alpha} + \frac{1}{E - K + i\epsilon} (H - K) \Psi_{\alpha}^{(+)}(E) \\ &= \chi_{\alpha} + \frac{1}{E - H + i\epsilon} (U + V) \chi_{\alpha} \\ &= \phi_{\alpha}^{(+)}(E) + \frac{1}{E - H + i\epsilon} V \phi_{\alpha}^{(+)}(E) , \end{aligned} \quad (\text{C1})$$

where  $\chi_{\alpha}$  is the plane-wave state, and

$$\phi_{\alpha}^{(+)}(E) = \chi_{\alpha} + \frac{1}{E - K - U + i\epsilon} U \chi_{\alpha} \quad (\text{C2a})$$

$$= \chi_{\alpha} + \frac{1}{E - K + i\epsilon} U \phi_{\alpha}^{(+)}(E) , \quad (\text{C2b})$$

is the total wave function for the two-nucleon system.

The pion-production amplitude  $T_{\alpha}(E)$  is defined by

$$T_{\alpha}(E) = (\chi_{\beta} | [(V + U), c_{\vec{k}}] | \Psi_{\alpha}^{(+)}(E)) , \quad (\text{C3})$$

where  $c_{\vec{k}}^{\dagger}$  is the creation operator for a pion with momentum  $\vec{k}$ . (For convenience  $c_{\vec{k}=0}^{\dagger} \equiv c^{\dagger}$  in the text of the paper.) Substituting

$$\chi_{\beta} = \phi_{\beta}^{(-)} - \frac{1}{E - K + i\epsilon} U \phi_{\beta}^{(-)} \quad (\text{C4})$$

into (C3) we obtain

$$T_{\alpha}(E) = (\phi_{\beta}^{(-)} | [(U + V), c_{\vec{k}}] | \Psi_{\alpha}^{(+)}(E)) - (\phi_{\beta}^{(-)} | U \frac{1}{E - K + i\epsilon} [(U + V), c_{\vec{k}}] | \Psi_{\alpha}^{(+)}(E)) . \quad (\text{C5})$$

After some manipulating using (C1) we arrive at

$$T_{\alpha}(E) = (\phi_{\beta}^{(-)} | [(U + V - U), c_{\vec{k}}] | \Psi_{\alpha}^{(+)}(E)) \quad (\text{C6})$$

$$= (\phi_{\beta}^{(-)} | [V, c_{\vec{k}}] | \Psi_{\alpha}^{(+)}(E)) \quad (\text{C7})$$

$$= (\phi_{\beta}^{(-)} | [V, c_{\vec{k}}] | \phi_{\alpha}^{(+)}(E)) + (\phi_{\beta}^{(-)} | [V, c_{\vec{k}}] \frac{1}{E - H + i\epsilon} V | \phi_{\alpha}^{(+)}(E)) . \quad (\text{C8})$$

Equations (C7) and (C8) are exact results. The usual distorted-wave approximation assumes the second term in (C8) to be small when compared with the first. Then, the distorted-wave amplitude  $T_{\alpha}^{\text{DW}}(E)$  is

$$T_{\alpha}^{\text{DW}}(E) = (\phi_{\beta}^{(-)} | [V, c_{\vec{k}}] | \phi_{\alpha}^{(+)}(E)) .$$

## APPENDIX D.

To derive (III.16) from (III.15) the following relations are used:

$$\begin{aligned}\Omega^{(-)\dagger}(E_0) - 1 &= \Omega^{(-)\dagger} U \frac{1}{E_0 - K} = t^{(-)\dagger}(E_0) \frac{1}{E_0 - K} \\ &= t^{(+)}(E_0) \frac{1}{E_0 - K} = U \frac{1}{E_0 - K - U},\end{aligned}$$

$$E_0 = E_f,$$

$$[K, \vec{\sigma} \cdot \vec{\nabla}] = 0,$$

$$\phi_\alpha^{(+)}(E) = \left[ 1 + \frac{1}{E - K + i\epsilon} t^{(+)}(E) \right] \chi_\alpha,$$

$$U \phi_\alpha^{(+)}(E) = t^{(+)}(E) \chi_\alpha.$$

Since the second term in (III.16) requires a maximum amount of manipulation it is done here to show the technique.

$$\begin{aligned}\left( \chi_\beta \left| \sum_{n=3}^4 \frac{\vec{\sigma}_n \cdot \vec{\nabla}_n}{M} \Omega^{(-)\dagger}(E_0) U \frac{m_\pi}{E_0 - K} \right| \phi_\alpha^{(+)}(E) \right) &= \left( \chi_\beta \left| \sum_{n=3}^4 \frac{\vec{\sigma}_n \cdot \vec{\nabla}_n}{M} U \frac{m_\pi}{E_0 - K - U} \right| \phi_\alpha^{(+)}(E) \right) \\ &= \left( \chi_\beta \left| \sum_{n=3}^4 \frac{\vec{\sigma}_n \cdot \vec{\nabla}_n}{M} \frac{m_\pi}{E_0 - E} U \right| \phi_\alpha^{(+)}(E) \right) \\ &= \left( \chi_\beta \left| \sum_{n=3}^4 \frac{\vec{\sigma}_n \cdot \vec{\nabla}_n}{M} \frac{m_\pi}{K - E + i\epsilon} t^{(+)}(E) \right| \chi_\alpha \right).\end{aligned}$$

(All factors of  $E_0$  contain a small positive imaginary part.)

\*Address beginning September 1970: Service de Physique Théorique, Centre d'Etudes Nucléaires, Saclay, France.

†Address beginning September 1970: Department of Physics, Kansas State University, Manhattan, Kansas 66502.

<sup>1</sup>S. Fubini and G. Furlan, *Ann. Phys. (N.Y.)* **48**, 322 (1968).

<sup>2</sup>For a review of previous work on pion production in nucleon-nucleon collisions see D. S. Koltun, in *Advances in Nuclear Physics*, edited by M. Baranger and E. Vogt (Plenum Press, New York, 1969), Vol. 3, pp. 160-167.

<sup>3</sup>M. Ericson, A. Figureau, and A. Molinari, *Nucl. Phys. B10*, 501 (1969).

<sup>4</sup>We use the conventions of J. D. Bjorken and S. D. Drell, *Relativistic Quantum Fields* (McGraw-Hill Book Company, Inc., New York, 1965).

<sup>5</sup>We use the conventions of S. L. Adler and R. F. Dashen, *Current Algebras and Applications to Particle Physics* (W. A. Benjamin, Inc., New York, 1968).

<sup>6</sup>S. L. Adler, *Phys. Rev.* **139**, B1638 (1965).

<sup>7</sup>H. Genz and J. Katz, to be published; H. Genz, J. Katz, and S. Wagner, to be published.

<sup>8</sup>D. A. Wray, *Ann. Phys. (N.Y.)* **51**, 162 (1969).

<sup>9</sup>M. Sugawara, *Phys. Rev.* **172**, 1423 (1968).

<sup>10</sup>M. K. Banerjee and C. A. Levinson, University of Maryland Technical Report No. 857, 1968 (unpublished); to be published.

<sup>11</sup>S. Weinberg, *Phys. Rev. Letters* **17**, 168 (1966);

Y. Tomozawa, *Nuovo Cimento* **46A**, 707 (1966); K. Raman and E. C. G. Sudarshan, *Phys. Letters* **21**, 450 (1966); A. P. Balachandran *et al.*, *Nuovo Cimento* **44A**, 1257 (1966).

<sup>12</sup>M. L. Goldberger, M. T. Grisaru, S. W. MacDowell, and D. Y. Wong, *Phys. Rev.* **120**, 2250 (1960).

<sup>13</sup>See, for example, D. Y. Wong, *Rev. Mod. Phys.* **39**, 629 (1967), and references cited therein.

<sup>14</sup>D. Beder, *Nuovo Cimento* **56A**, 625 (1968); **58A**, 908(E) (1968); M. Schillaci, R. Silbar, and J. Young, *Phys. Rev. Letters* **21**, 711, 1030(E) (1968); *Phys. Rev.* **179**, 1539 (1969).

<sup>15</sup>M. Gell-Mann and M. Levy, *Nuovo Cimento* **16**, 705 (1960).

<sup>16</sup>This discussion is very similar to the optical-model discussion of M. L. Goldberger and K. M. Watson, *Collision Theory* (John Wiley & Sons, Inc., New York, 1964), pp. 788-790.

<sup>17</sup>D. S. Koltun and A. Reitan, *Phys. Rev.* **141**, 1413 (1966).

<sup>18</sup>A. Reitan, *Nucl. Phys.* **B11**, 170 (1969).

<sup>19</sup>S. Mandelstam, *Proc. Roy. Soc. (London)* **A244**, 491 (1958).

<sup>20</sup>The relativistic corrections for pion production in nucleon-nucleon collisions have been studied from a different point of view by J. E. Young, *Ann. Phys. (N.Y.)* **56**, 391 (1970).

<sup>21</sup>This review follows closely Goldberger and Watson, *Ref. 16*, pp. 202-209.